

e:cue



DMX2PWM 3ch Setup Manual

e:cue DMX2PWM 3ch Setup Manual (original issue)

Edition: 17.01.2022 [EN_DMX2PWM_3ch_Setup_v1p12]

Published by:

OSRAM GmbH
BU Digital
Karl-Schurz-Strasse 38
33100 Paderborn, Germany

©2022, OSRAM GmbH, BU Digital
All rights reserved

Subject to modification without prior notice. Typographical and other errors do not justify any claim for damages. All dimensions should be verified using an actual part.

Except for internal use, relinquishment of the instructions to a third party, duplication in any type or form - also extracts - as well as exploitation and/or communication of the contents is not permitted.

Table of Contents

1	Safety instructions	4
2	General installation guidelines	4
3	Delivery scope	5
4	Installation	5
5	DMX	8
5.1	Pin assignment	8
6	Device setup	9
6.1	Manual addressing.....	9
6.2	Auto addressing.....	9
6.3	External power source	10
7	Status LEDs	10
8	Dimming curve	11
9	Technical data	13
10	Certifications	14
11	Dimensions	15

1 Safety instructions



Only use the device in compliance with the environmental conditions specified and watch the technical characteristics. Otherwise the unit may be damaged or malfunction will happen.



To prevent the device from overheating, only operate it in well-ventilated environment. Ventilation may not be obstructed. Do not install next to heat emitting sources or in a place subject to direct sunlight. Overheating damages the device.



Device components inside the system can reach high temperatures! To avoid burns, allow the unit to cool for at least 20 minutes before unmounting or repair.



Installation and maintenance of this product must be performed by individuals who are knowledgeable about the procedures, precautions and hazards associated with the product.

2 General installation guidelines



Do not route network, DMX or any other communication line together with power lines. Data traffic or functions can be disturbed.



We strongly recommend keeping the dl/dt^{*)} loop as small as possible. Install the dimmers, PSUs, and LED modules as close together as possible.



The high dl/dt cables shall not be installed close to the DMX data cables.



For DMX and power, it is recommended to use shielded cables only and to connect the shield to earth.

^{*)} dl/dt means high current pulses caused by PWM dimming. These pulses may interfere with the DMX signal.

3 Delivery scope

- DMX2PWM 3ch dimmer
- Setup Manual (English only)
- 2-pin screw terminal plug (power supply)
- 6-pin screw terminal plug (LED connection)

Order code

AA623900135

4 Installation

The PWM switching node is designed as a low-side switch and is able to handle a maximum current of 2.5 A. Each output channel is short circuit protected. As soon as an over-current or short circuit situation is detected, the switch of the corresponding channel will immediately shut down. The yellow STATUS LED is blinking to signal the over-current error. The dimmer tests the output repeatedly if the over-current still exists. It will re-enable the output as soon as the over-current or short circuit is removed.

For use of the DMX2PWM dimmer device a DC power supply unit is necessary. The choice of the power supply voltage only depends on the supply voltage of your LED fixtures, but must remain in the range from 12 V to 48 V DC. Please consider that the power supply must be able to provide the current for the connected LED fixtures and the DMX2PWM dimmer. Multiple LED fixtures where each one needs a different voltage level cannot be used with one dimmer device at the same time.

Always select the power supply output voltage accordingly to your LED fixture input voltage: 12 V PSU for 12 V LEDs, 24 V PSU for 24 V LEDs, 48 V PSU for 48 V LEDs.

The “+” line of the Power supply connection (PWR In) is directly routed to the “+” connection of each PWM output. The following picture shows the basic connection scheme:

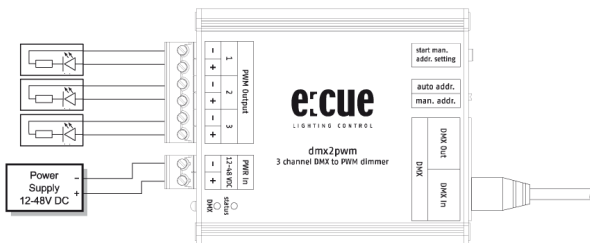

The advantage of the above shown type of connection is the reverse supply protection of all LED fixtures and the dimmer itself. Alternatively it is also possible to connect LED fixtures as shown in the figure below.

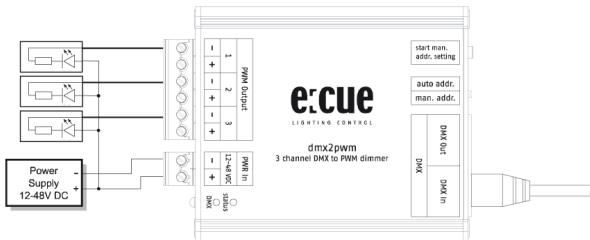

Due to the PWM dimming concept, the current sourcing the LED modules is being switched on and off with a high frequency by the dimmer. The cables which carry the current pulses (dI/dt cables) shall be kept as a short as possible to not cause interferences or radiation. It is strongly recommended to keep data cables, such as DMX, away from the dashed marked cables shown in the picture below. The use of shielded cables is also recommended.

The following pictures shows the di/dt cabling; the dashed lines as the high current loop (high di/dt):

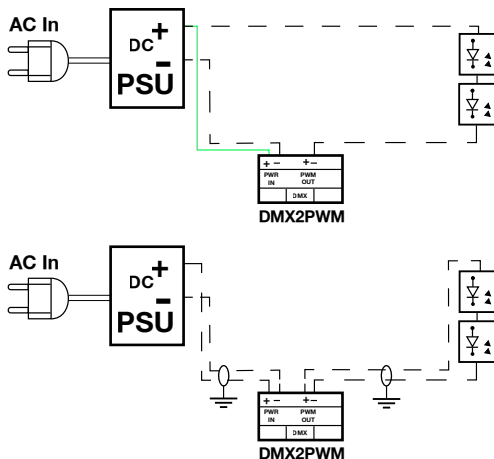

Always select the power supply output voltage accordingly to your LED fixture input voltage. Make sure that the power supply cables are specified to carry the complete amount of current needed by the connected LED fixtures. We recommend to install the dimmers, PSUs, and LED modules as close together as possible. We recommend to not install the power cable close to the DMX data cable.



5 DMX

A DMX master must be attached to the DMX-In connector. If a valid DMX signal is detected by the DMX2PWM, the green DMX LED is on. T

Use shielded cables only.

o connect multiple devices in a chain, connect the DMX Out port of the first device to the DMX-In port of the next device. For details about setting up a DMX address, please refer to the corresponding chapter.

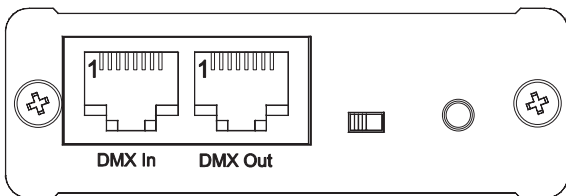

5.1 Pin assignment

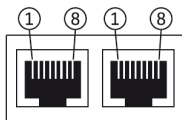

Pin	Connection
1	DMX-
2	DMX+
3, 7	Gnd

6 Device setup

6.1 Manual addressing

The DMX2PWM dimmer has no switches for setting up the DMX address, instead you configure the first DMX address for the device by sending a DMX data frame. To use manual addressing, the switch must be set to MAN. ADDR.. When you press the button START for at least one second and then release it, the DMX LED starts blinking. The device now listens and waits for a DMX configuration data frame. The first received DMX data byte which is not zero is used as the device's base address (address of PWM output 1).

Example:

- The first received DMX data byte other than zero is located at address 11 when the device is in listening mode. Address 11 will now be stored as start address for PWM output channel 1. Channels 2 and 3 are then automatically configured the address 12 and 13. The base address is stored into a non-volatile memory so that address is present after repowering the device.

To abort the listening mode without any changes, simply press the button for less than one second. The STATUS LED stops blinking.

To reset the device to base address 1 without sending a configuration data frame, press and hold the button for one second. The DMX LED starts blinking. Then press and hold the button for one second again. The DMX LED stops blinking and the address is set back to 1. It is of no importance whether the DMX cable is connected or not.

6.2 Auto addressing

Auto addressing mode should be used when connecting several DMX2PWM dimmers in a chain. The first device in a chain occupies the DMX addresses 1, 2 and 3. The next one, which is connected to the DMX-Out connector of the previous one, uses addresses 4, 5 and 6 and so on.

If a base address is already set (see manual address setting), the device also uses this address in auto addressing mode as its base address.

Examples:

- The first device in the chain has the base address 6 (and also occupies addresses 7 and 8), the next device has the base address 9.
- The first device in the chain has been configured for base address 2 and the next device has the base address 4. The result is that the first device occupies the address 2, 3 and 4 and the next device uses address 8, 9 and 10.

To avoid confusion when using the auto addressing mode it is recommended to reset the base addresses of all devices to 1.

6.3 External power source

The housing version of the DMX2PWM is equipped with a jumper (J1) to enable power sourcing on the DMX-In connector pin 5. The default setting at delivery is off (position 2-3). When enabled (position 1-2), the power supply is directly routed to pin 5 of the RJ45 connector. This is especially useful when using the e:cue Glass Touch user terminals. No other additional power supply is needed.

7 Status LEDs

LED	Description
DMX off or flickering	No DMX signal recognized or not connected
DMX on	DMX present
DMX blinking	Awaiting DMX data frame for manual address setting
STATUS off	Power supply not connected
STATUS on	Normal operation
STATUS blinking	Overcurrent detected on one or more channels

8 Dimming curve

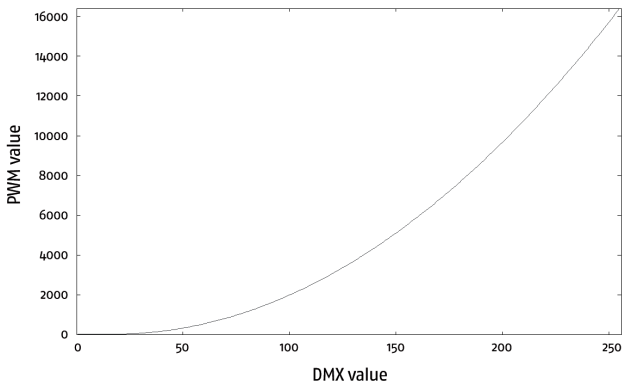

The dimming of the LEDs is accomplished by a pulse width modulation with a basic frequency of $f=488$ Hz. Due to the 14 bit PWM resolution, the “On-time” can be adjusted in 125 ns steps. To achieve a more “linear” impression of the LED’s brightness, a translation from the 8 bit DMX value to the 14 bit PWM resolution in form of a dimming curve is implemented.

The following picture shows the principle of PWM dimming. Please keep in mind the DMX2PWM’s switching node is a low-side switch, which means that the LED is on when the (-) connector is switched to GND (low).

Low-Side switch: low= on, high= off

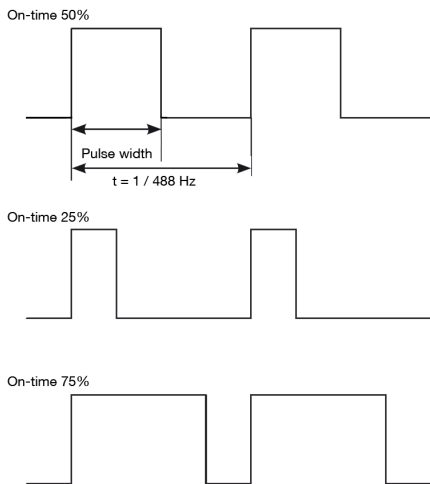

9 Technical data

Dimensions (WxHxD)	94 x 71,5 x 24 mm/63.66 x 2.81 x 0.94 inch
Weight	0,08 kg/0.176 lbs
Power	12 ... 48 V DC (screw term.)
Power consumption	0.6 W (idle, all channels off, DMX connected)
Max. output current/channel	2.5 A (overcurrent protection, $\pm 10\%$) @ 0 ... 50 °C/ 32 ... 122 °F ambient temperature 2.0 A (overcurrent protection, $\pm 10\%$) @ 50 ... 60 °C / 122 ... 140 °F ambient temperature
Max. output load capacitance	1 μ F
Over-current retry delay	1 sec.
Minimum on time	2.5 μ s
PWM frequency	488 Hz
PWM resolution	14 bit (optimized dimming curve calculated from 8 bit DMX value)
Operating temperature	0 ... 50° C / 32 ... 122° F
Storage temperature	-20 ... 85° C / -4 ... 185° F
Operating/storage hum.	0 ... 90%, non condensing
Protection class	IP20
Housing	Aluminium
Certifications	CE, ETL, UKCA
Input	DMX512 (RJ45)
Outputs	DMX512 (RJ45) 3 LED output channels (screw term. + connector: identical to input voltage - connector: low side PWM switch
Data protocols	DMX512-A and e:pix
Max. devices in a chain	32 (depends on cable length and quality)
Max. wire cross section	1.5 mm ² (screw terminals, power supply and PWM outputs)

10 Certifications



Intertek

4000805

Conforms to ANSI/UL Std. 60950-1
Certified to CSA Std. C22.2 NO. 60950-1



11 Dimensions

All dimensions in mm and inch.

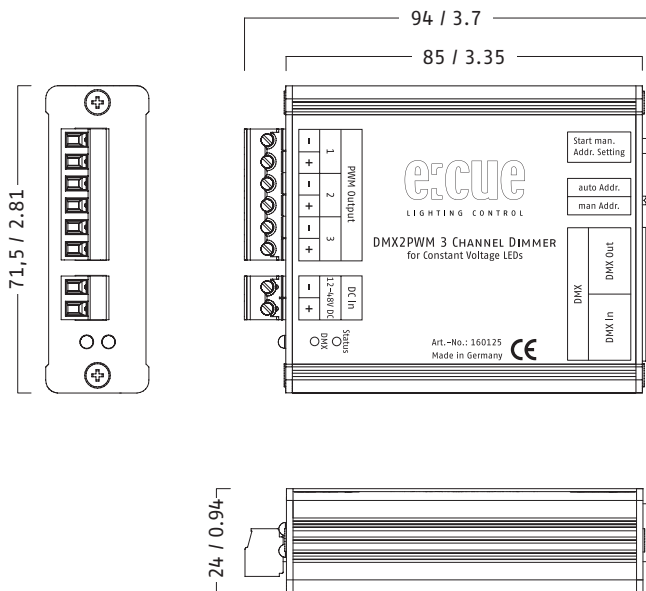

ecue

L I G H T I N G C O N T R O L

Downloads and more information at

www.ecue.com and www.traxontechnologies.com