

Project: \_\_\_\_\_  
 Type: \_\_\_\_\_

## Media Pixel Ribbon White HB Outdoor



The Traxon Media Pixel Ribbon VB is an IP67 flexible neon strip which can be controlled directly using DMX512. The vertical bending (VB), together with the horizontal bending (HB) Ribbon provides flexibility to fit on any curved surface to accommodate architectural structures. Featuring a 0.66" / 16.7 mm LED pitch with a 3.9" / 100 mm pixel pitch, the Media Pixel Ribbon is available in an assortment of colors and CCT options, has multiple mounting options to meet project needs, and is able to be customized for number of pixels, ribbon lengths, and cable feed position.



### Product Specifications

Models	W 6500K	W 4000K	W 3000K	W 2700K
<b>Light Source</b>	High intensity SMT White LEDs			
<b>Pixels</b>	61 pixels per roll 3 pixels per ft / 10 pixels per m <sup>1</sup>			
<b>LED pitch</b>	0.66" / 16.7 mm			
<b>Pixel Pitch</b>	3.9" / 100 mm			
<b>Cutting Pitch</b>	3.9" / 100 mm			
<b>CRI for White LED</b>	> 80			
<b>SDCM for White LED</b>	3-steps			
<b>Luminous Flux</b>	73 lm per ft 240 lm per m	73 lm per ft 240 lm per m	70 lm per ft 230 lm per m	67 lm per ft 220 lm per m
<b>Efficacy</b>	26 lm/W	26 lm/W	25 lm/W	24 lm/W
<b>Beam Angle</b>	120°			
<b>Housing</b>	UV resistant diffused silicone			
<b>Dimensions (W x H)</b>	0.4" x 0.5" / 10 mm x 12 mm			
<b>Max. length</b>	20' / 6.1m per roll			
<b>Weight (per roll)</b>	3.36 lb / 1525 g			
<b>Mounting</b>	Various mounting brackets and channels			
<b>Min. Bend Radius</b>	5.9" / 150 mm			
<b>Regulatory Listing &amp; Safety Approval</b>	cETLus, FCC, RoHS, REACH, IK08			
<b>Operating Temperature</b>	-4°F to 122°F / -20°C to +50°C			
<b>Storage Temperature</b>	-40°F to 158°F / -40°C to +70°C			
<b>Environment</b>	IP67 Outdoor Rated; suitable for coastal environments			
<b>Humidity</b>	0 to 90% non-condensing			

### Electrical Specifications

<b>Input Voltage</b>	24V DC
<b>Power Consumption (Typ.)</b>	2.9 W per foot / 9.6 W per meter

### System Specifications

<b>Control</b>	DMX512
<b>Power Supply</b>	185W 24V DC Outdoor
<b>Addressing Options</b>	Manual Addressing with 3rd party addressing device

1. Pixel per meter can be customized to 5 pixels, 2 pixels or 1 pixel.

Please consult regional sales office for more information, pricing and lead time.

**LED CHARACTERISTICS** Because LEDs are semiconductor devices, their performances are subject to inherent variability commonly found in semiconductor industry. To improve consistency in performance across the same product, LED manufacturers "sort" LEDs into bins according to different preset parameters, such as forward driving voltage, illumination, etc. Whereas binning is a sorting function, it is not a correction process. Inherent variability in the manufacturing process results always in different binning distributions according to different production lots. Traxon uses automatically binned LEDs on its products, thereby minimizing output variations within the model range.

As with all electronic devices, LED output degrades over time – a term called lumen depreciation. This also explains why it is nearly impossible to expect photometric performances of two LED products with different service life spans to be the same. The rate of LED degrade is a complicate function of many factors such as operating efficiency, duration of continuous operation, and more significantly, environmental conditions (ambient temperature for example). If allowed working under optimal operating temperature range and with good ventilation, LED devices enjoy long service lives over conventional light sources. When using/installing LED devices, care should be taken to ensure that the devices will operate within the operating conditions specified in respective product literature.

Lumen measurement complies with LM-79-08 standard.  
 Lumen maintenance is calculated based on LM-80 compliant measurement.

[www.traxontechnologies.com](http://www.traxontechnologies.com) | [www.osram.us/traxon](http://www.osram.us/traxon)

©2021 TRAXON TECHNOLOGIES - AN OSRAM BUSINESS. ALL RIGHTS RESERVED. TRAXON™, TX CONNECT®<sup>®</sup>, ARE TRADEMARKS OF TRAXON TECHNOLOGIES. U.S. PATENTS, E.U. PATENTS, JAPAN PATENTS, OTHER PATENTS PENDING. SPECIFICATIONS ARE SUBJECT TO CHANGE WITHOUT NOTICE.

## Source Specifications

LED Source High intensity SMT White LEDs

## Candela Distribution

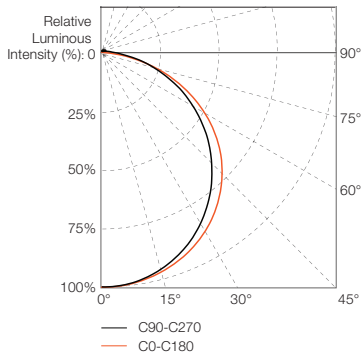

## Light Output

Color	Luminous Flux per ft (lm)	Center Intensity (cd)	Efficacy (lm/W)
<b>White</b>			
2700K	67	73	24
3000K	70	76	25
4000K	73	79	26
6500K	73	79	26

## Illuminance at a Distance

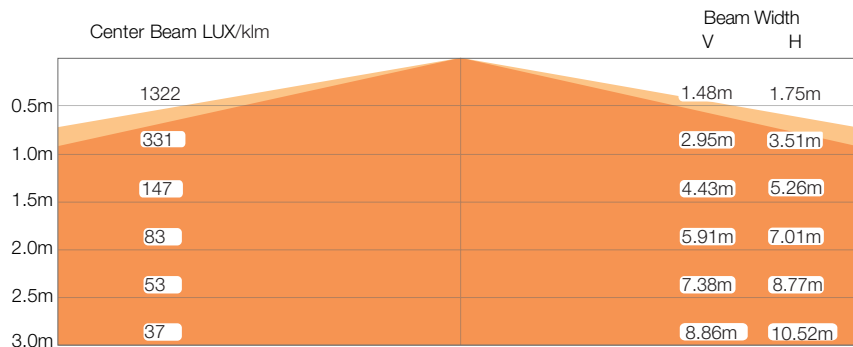

For feet multiply by 3.28

● Vert. Spread: 111.8°  
● Horiz. Spread: 120.6°  
 For fc divide by 10.7

IES and LDT files are available for download from the Traxon website.

Media Pixel Ribbon

End cable feed (H1)

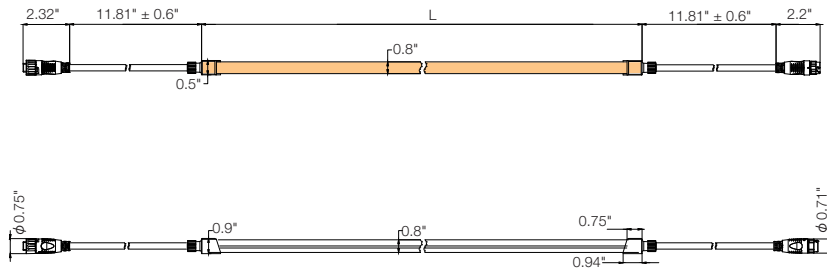

Left side cable feed (H2L)

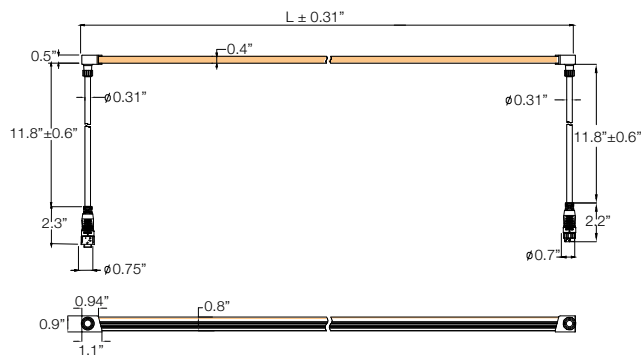

Right side cable feed (H2R)

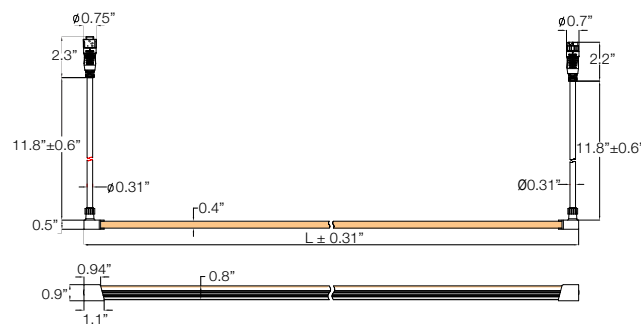

## Bottom cable feed (H3)

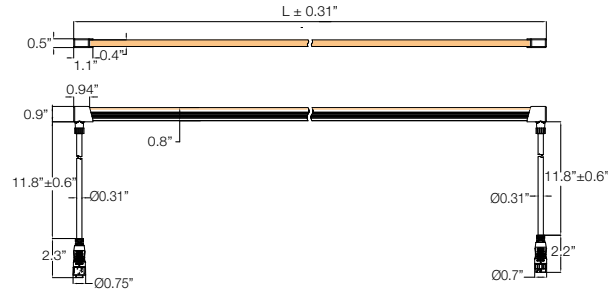

Model	Max. Ribbon length with single power feed	Actual product length with endcap at 2-ends, L
DW & W	20' / 6.1m	20'+0.8" / 6.1m+20mm

**Remark:** For other customized lengths (in multiples of 4" / 100 mm), the actual product length would be customized length + 0.8" / + 20mm.

## Connection Accessories

RB CONNECTOR ENDCAP 120OHMIP67 (AM400870055)

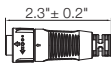

RB 5PIN STARTER CABLE 1M IP67 (AM400840055)  
RB 5PIN STARTER CABLE 3M IP67 (AM400850055)

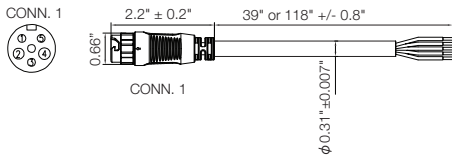

Wire#	Description	Color
1	Address(P)	Green
2	V-	Black
3	DMX+	Yellow
4	V+	Red
5	DMX-	Blue

RB RJ45 STARTER Y-CABLE IP67 (AM401000055)

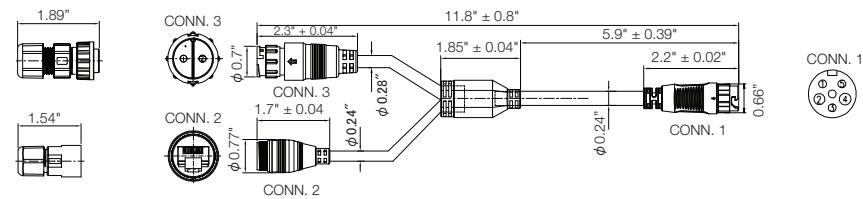

RB 5PIN POWER INJ Y-CABLE IP67 (AM400990055)

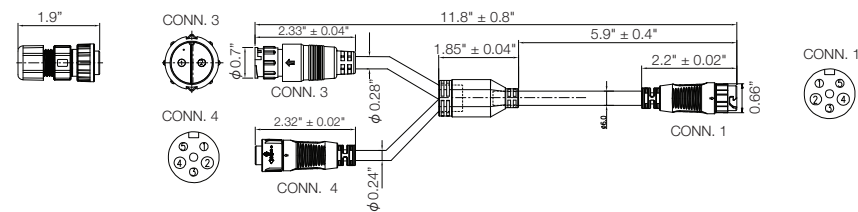

[www.traxontechnologies.com](http://www.traxontechnologies.com) | [www.osram.us/traxon](http://www.osram.us/traxon)

©2021 TRAXON TECHNOLOGIES - AN OSRAM BUSINESS. ALL RIGHTS RESERVED. TRAXON™, TX CONNECT®, ARE TRADEMARKS OF TRAXON TECHNOLOGIES. U.S. PATENTS, E.U. PATENTS, JAPAN PATENTS, OTHER PATENTS PENDING. SPECIFICATIONS ARE SUBJECT TO CHANGE WITHOUT NOTICE.

Mounting Accessories

Aluminium U-channel  
U-CHANNEL OUTDOOR HB 950 (AM400980055)

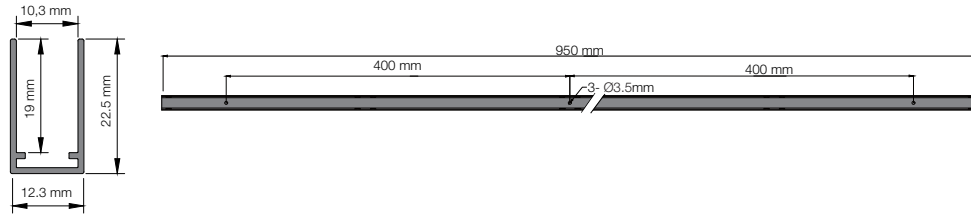

304 Stainless Steel Flexible Strip  
FLEXIBLE MOUNT STRIP HB 5M / ROLL (AM400940055)

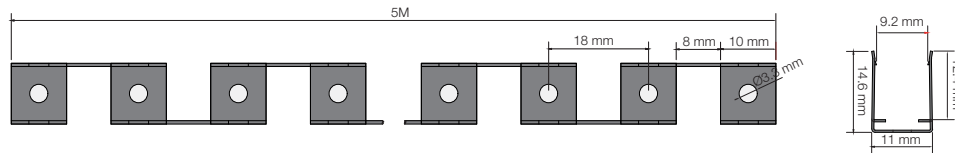

SINGLE MOUNT BRACKET HB (AM400960055)

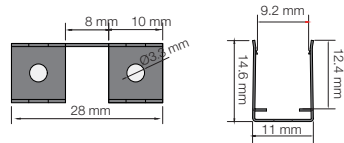

## Typical Wiring with 5-pin Starter Cable

NOTE: Mounting accessories not shown.

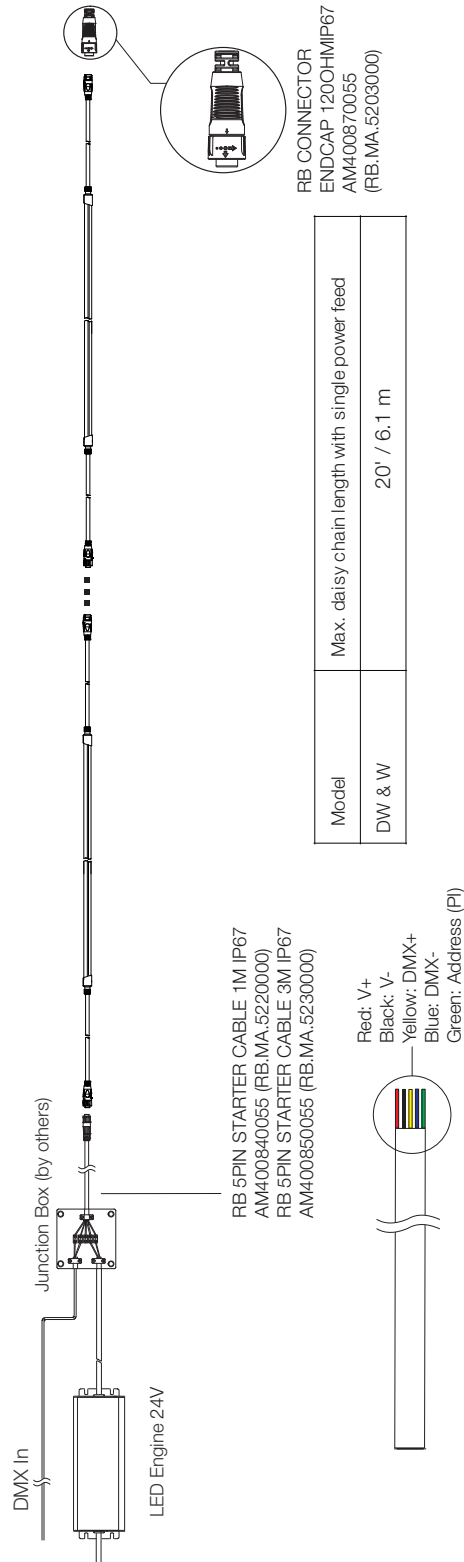

[www.traxontechnologies.com](http://www.traxontechnologies.com) | [www.osram.us/traxon](http://www.osram.us/traxon)

©2021 TRAXON TECHNOLOGIES - AN OSRAM BUSINESS. ALL RIGHTS RESERVED. TRAXON™, TX CONNECT® ARE TRADEMARKS OF TRAXON TECHNOLOGIES. U.S. PATENTS, E.U. PATENTS, JAPAN PATENTS, OTHER PATENTS PENDING. SPECIFICATIONS ARE SUBJECT TO CHANGE WITHOUT NOTICE.

## Typical Power Injection with Wiring Y-Cable

NOTE: Mounting accessories not shown.

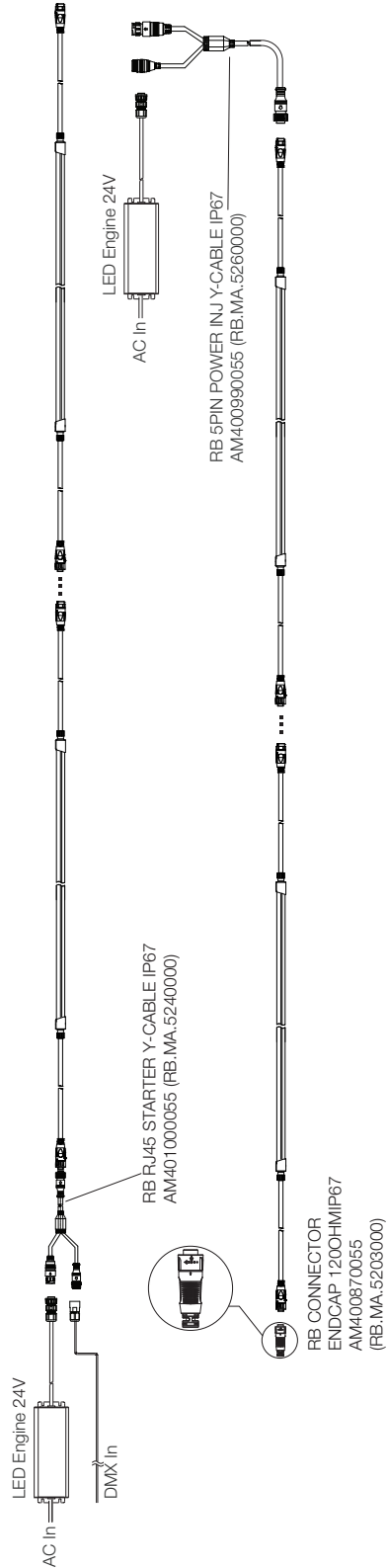

Power injection is required when ribbon connection length reaches the maximum length with single power feed.

## Media Pixel Ribbon White HB Outdoor

Ordering

### Fixtures

Model No.	Description	Item Code
RB.UO.6100200	PX RB 827 61PPR 20FT DX H1 IP67 ETL (END CABLE FEED)	AM433790055
RB.UO.6120200	PX RB 830 61PPR 20FT DX H1 IP67 ETL (END CABLE FEED)	AM433800055
RB.UO.6130200	PX RB 840 61PPR 20FT DX H1 IP67 ETL (END CABLE FEED)	AM433810055
RB.UO.6110200	PX RB 865 61PPR 20FT DX H1 IP67 ETL (END CABLE FEED)	AM433820055
RB.UO.6100220	PX RB 827 61PPR 20FT DX H2L IP67 ETL (SIDE CABLE FEED LEFT)	AM433860055
RB.UO.6120220	PX RB 830 61PPR 20FT DX H2L IP67 ETL (SIDE CABLE FEED LEFT)	AM433870055
RB.UO.6130220	PX RB 840 61PPR 20FT DX H2L IP67 ETL (SIDE CABLE FEED LEFT)	AM433880055
RB.UO.6110220	PX RB 865 61PPR 20FT DX H2L IP67 ETL (SIDE CABLE FEED LEFT)	AM433890055
RB.UO.6100290	PX RB 827 61PPR 20FT DX H2R IP67 ETL (SIDE CABLE FEED RIGHT)	AM433930055
RB.UO.6120290	PX RB 830 61PPR 20FT DX H2R IP67 ETL (SIDE CABLE FEED RIGHT)	AM433940055
RB.UO.6130290	PX RB 840 61PPR 20FT DX H2R IP67 ETL (SIDE CABLE FEED RIGHT)	AM433950055
RB.UO.6110290	PX RB 865 61PPR 20FT DX H2R IP67 ETL (SIDE CABLE FEED RIGHT)	AM433960055
RB.UO.6100230	PX RB 827 61PPR 20FT DX H3 IP67 ETL (BOTTOM CABLE FEED)	AM434000055
RB.UO.6120230	PX RB 830 61PPR 20FT DX H3 IP67 ETL (BOTTOM CABLE FEED)	AM434010055
RB.UO.6130230	PX RB 840 61PPR 20FT DX H3 IP67 ETL (BOTTOM CABLE FEED)	AM434020055
RB.UO.6110230	PX RB 865 61PPR 20FT DX H3 IP67 ETL (BOTTOM CABLE FEED)	AM434030055

### TX Connect

Model No.	Description	Item Code
RB.MA.5220000	RB 5PIN STARTER CABLE 1M IP67	AM400840055
RB.MA.5230000	RB 5PIN STARTER CABLE 3M IP67	AM400850055
RB.MA.5270000	RB 5PIN STARTER CABLE 5M IP67	AM415500055
RB.MA.5260000	RB 5PIN POWER INJ Y-CABLE IP67	AM400990055
RB.MA.5240000	RB RJ45 STARTER Y-CABLE IP67	AM401000055
N/A	RB CONNECTOR ENDCAP IP67	AM400860055
RB.MA.5203000	RB CONNECTOR ENDCAP 120OHM IP67	AM400870055

### TX Cutting tools

Model No.	Description	Item Code
N/A	PX RIBBON CUTTING TOOL	AM412950055
N/A	PX RIBBON SEALING GLUE 100ML	AM412960055
N/A	RX RIBBON HB FIELD CUT ENDCAP 20PC	AM412980055

### TX Mounting

Model No.	Description	Item Code
N/A	FLEXIBLE MOUNT STRIP HB 5M	AM400940055
N/A	SINGLE MOUNT BRACKET HB 20PC	AM400960055
N/A	U-CHANNEL OUTDOOR HB 950	AM400980055

### TX Power Supply

Model No.	Description	Item Code
N/A	LED ENGINE 100W 24V OUTDOOR	AM175860055

### Addressing Device

Please contact your sales representative for details.

### Our Brands

traxon e:cue

www.traxontechnologies.com | www.osram.us/traxon

OSRAM

©2021 TRAXON TECHNOLOGIES - AN OSRAM BUSINESS. ALL RIGHTS RESERVED. TRAXON™, TX CONNECT®, ARE TRADEMARKS OF TRAXON TECHNOLOGIES. U.S. PATENTS, E.U. PATENTS, JAPAN PATENTS, OTHER PATENTS PENDING. SPECIFICATIONS ARE SUBJECT TO CHANGE WITHOUT NOTICE.