

Project: \_\_\_\_\_

Type: \_\_\_\_\_

## Media Pixel Ribbon RGB VB Outdoor



The Traxon Media Pixel Ribbon VB is an IP67 flexible neon strip which can be controlled directly using DMX512. The vertical bending (VB), together with the horizontal bending (HB) Ribbon provides flexibility to fit on any curved surface to accommodate architectural structures. Featuring a 0.66" / 16.7 mm LED pitch with a 3.9" / 100 mm pixel pitch, the Media Pixel Ribbon is available in an assortment of colors and CCT options, has multiple mounting options to meet project needs, and is able to be customized for number of pixels, ribbon lengths, and cable feed position.



IK08

### Product Specifications

<b>Models</b>	RGB
<b>Light Source</b>	High intensity SMT RGB LEDs
<b>Color Range</b>	16.7 Million additive RGB colors
<b>Pixels</b>	61 pixels per roll 3 pixels per ft / 10 pixels per m <sup>1</sup>
<b>LED pitch</b>	0.66" / 16.7 mm
<b>Pixel Pitch</b>	3.9" / 100 mm
<b>Cutting Pitch</b>	3.9" / 100 mm
<b>Luminous Flux</b>	61 lm per ft / 200 lm per m
<b>Efficacy</b>	18 lm/W
<b>Beam Angle</b>	120°
<b>Housing</b>	UV resistant diffused silicone
<b>Dimensions (W x H)</b>	0.6" x 0.63" / 15 mm x 16 mm
<b>Max. length</b>	20' / 6.1m per roll
<b>Weight (per roll)</b>	3.5 lb / 1601 g
<b>Mounting</b>	Various mounting brackets and channels
<b>Min. Bend Radius</b>	5.9" / 150 mm
<b>Regulatory Listing &amp; Safety Approval</b>	cETLus, FCC, RoHS, REACH, IK08
<b>Operating Temperature</b>	-4°F to 122°F / -20°C to +50°C
<b>Storage Temperature</b>	-40°F to 158°F / -40°C to +70°C
<b>Environment</b>	IP67 Outdoor Rated; suitable for coastal environments
<b>Humidity</b>	0 to 90% non-condensing

### Electrical Specifications

<b>Input Voltage</b>	24V DC
<b>Power Consumption (Typ.)</b>	3.4 W per foot / 11 W per meter

### System Specifications

<b>Control</b>	DMX512
<b>Power Supply</b>	100W 24V DC Outdoor
<b>Addressing Options</b>	Addressing with 3rd party addressing device

1. Pixel per meter can be customized to 5 pixels, 2 pixels or 1 pixel.

Please consult regional sales office for more information, pricing and lead time.

**LED CHARACTERISTICS** Because LEDs are semiconductor devices, their performances are subject to inherent variability commonly found in semiconductor industry. To improve consistency in performance across the same product, LED manufacturers "sort" LEDs into bins according to different preset parameters, such as forward driving voltage, illumination, etc. Whereas binning is a sorting function, it is not a correction process. Inherent variability in the manufacturing process results always in different binning distributions according to different production lots. Traxon uses automatically binned LEDs on its products, thereby minimizing output variations within the model range.

As with all electronic devices, LED output degrades over time – a term called lumen depreciation. This also explains why it is nearly impossible to expect photometric performances of two LED products with different service life spans to be the same. The rate of LED degrade is a complicate function of many factors such as operating efficiency, duration of continuous operation, and more significantly, environmental conditions (ambient temperature for example). If allowed working under optimal operating temperature range and with good ventilation, LED devices enjoy long service lives over conventional light sources. When using/installing LED devices, care should be taken to ensure that the devices will operate within the operating conditions specified in respective product literature.

Lumen measurement complies with LM-79-08 standard.  
Lumen maintenance is calculated based on LM-80 compliant measurement.

[www.traxontechnologies.com](http://www.traxontechnologies.com) | [www.osram.us/traxon](http://www.osram.us/traxon)

©2021 TRAXON TECHNOLOGIES - AN OSRAM BUSINESS. ALL RIGHTS RESERVED. TRAXON™, TX CONNECT®, ARE TRADEMARKS OF TRAXON TECHNOLOGIES. U.S. PATENTS, E.U. PATENTS, JAPAN PATENTS, OTHER PATENTS PENDING. SPECIFICATIONS ARE SUBJECT TO CHANGE WITHOUT NOTICE.

## Source Specifications

**LED Source** High intensity SMT RGB LEDs

## Candela Distribution

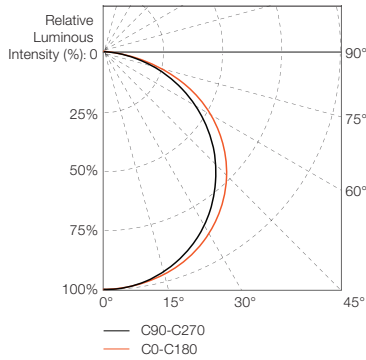

## Light Output

Color	Luminous Flux per ft (lm)	Center Intensity (cd)	Efficacy (lm/W)
<b>RGB</b>			
<b>RGB (full-on)</b>	61	66	18
<b>Red</b>	7	8	9
<b>Green</b>	20	22	27
<b>Blue</b>	4	4	5

## Illuminance at a Distance

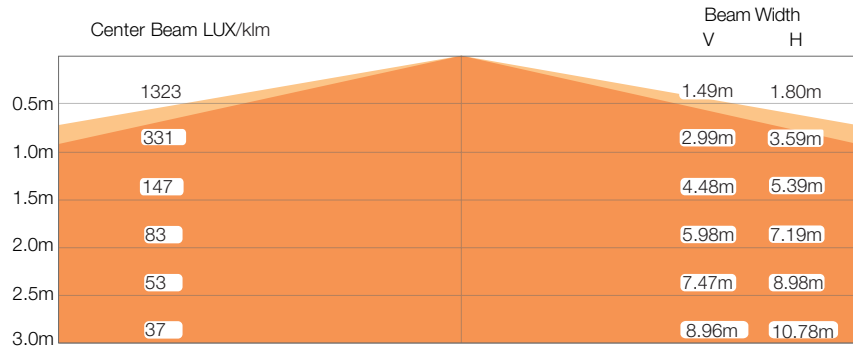

For feet multiply by 3.28

● Vert. Spread: 112.4°  
● Horiz. Spread: 121.8°  
 For fc divide by 10.7

IES and LDT files are available for download from the Traxon website.

Media Pixel Ribbon

End cable feed (V1)

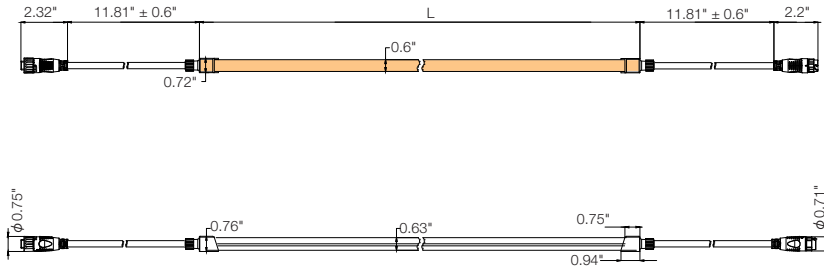

Left side cable feed (V2L)

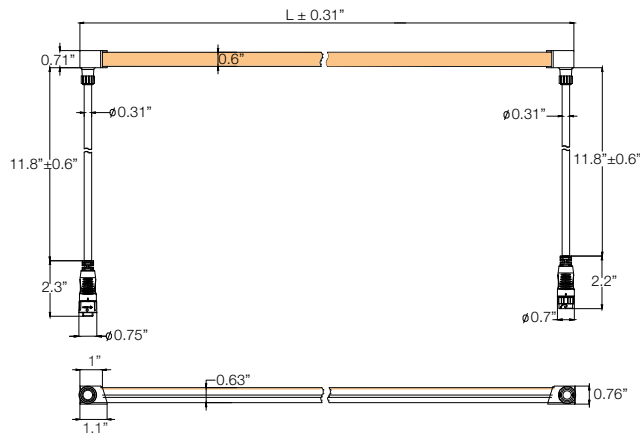

Right side cable feed (V2R)

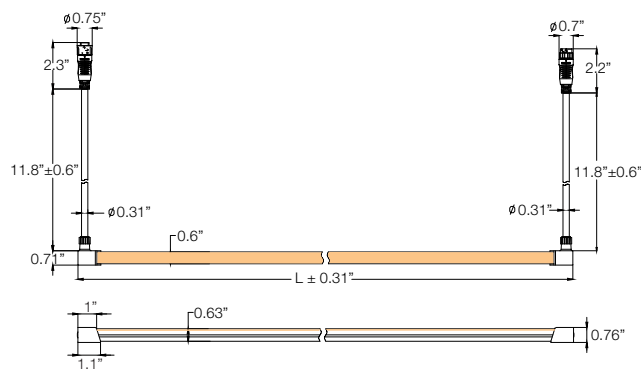

## Bottom cable feed (V3)

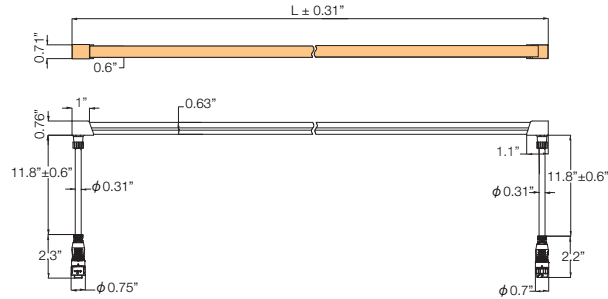

Model	Max. Ribbon length with single power feed	Actual product length with endcap at 2-ends, L
RGB+W & RGB	20' / 6.1m	20'+0.8" / 6.1m+20mm

**Remark:** For other customized lengths (in multiples of 4" / 100 mm), the actual product length would be customized length + 0.8" / + 20mm.

## Connection Accessories

RB CONNECTOR ENDCAP 120OHMIP67 (AM400870055)

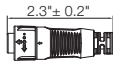

RB 5PIN STARTER CABLE 1M IP67 (AM400840055)  
RB 5PIN STARTER CABLE 3M IP67 (AM400850055)

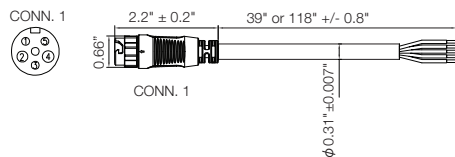

Wire#	Description	Color
1	Address(P)	Green
2	V-	Black
3	DMX+	Yellow
4	V+	Red
5	DMX-	Blue

RB RJ45 STARTER Y-CABLE IP67 (AM401000055)

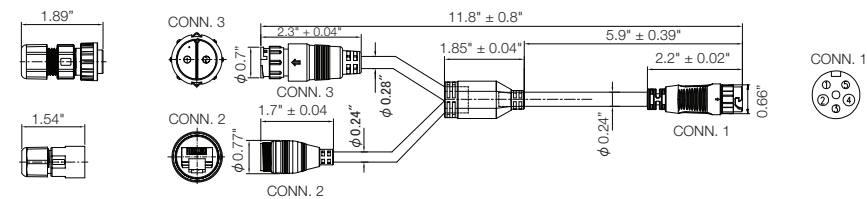

RB 5PIN POWER INJ Y-CABLE IP67 (AM400990055)

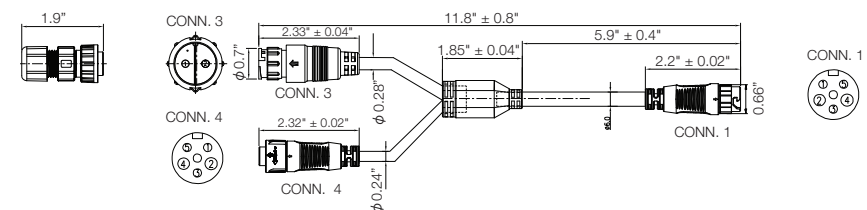

[www.traxontechnologies.com](http://www.traxontechnologies.com) | [www.osram.us/traxon](http://www.osram.us/traxon)

©2021 TRAXON TECHNOLOGIES - AN OSRAM BUSINESS. ALL RIGHTS RESERVED. TRAXON™, TX CONNECT® ARE TRADEMARKS OF TRAXON TECHNOLOGIES. U.S. PATENTS, E.U. PATENTS, JAPAN PATENTS, OTHER PATENTS PENDING. SPECIFICATIONS ARE SUBJECT TO CHANGE WITHOUT NOTICE.

Mounting Accessories

Aluminium U-channel  
U-CHANNEL OUTDOOR VB 950 (AM400970055)

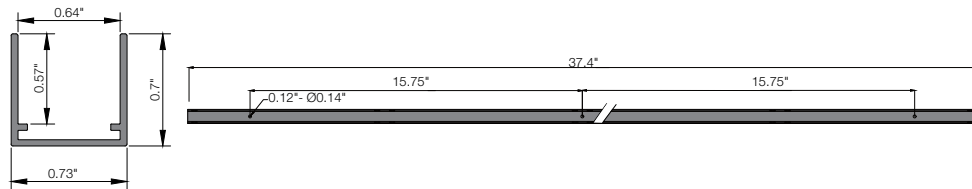

304 Stainless Steel Flexible Strip  
FLEXIBLE MOUNT STRIP VB 196\" / ROLL (AM400930055)

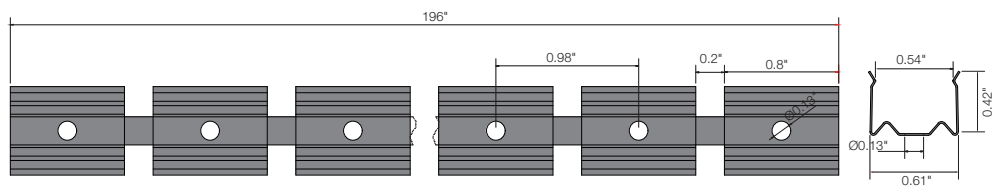

SINGLE MOUNT BRACKET VB (AM400950055)

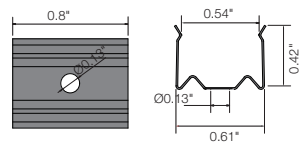

## Typical Wiring with 5-pin Starter Cable

NOTE: Mounting accessories not shown.

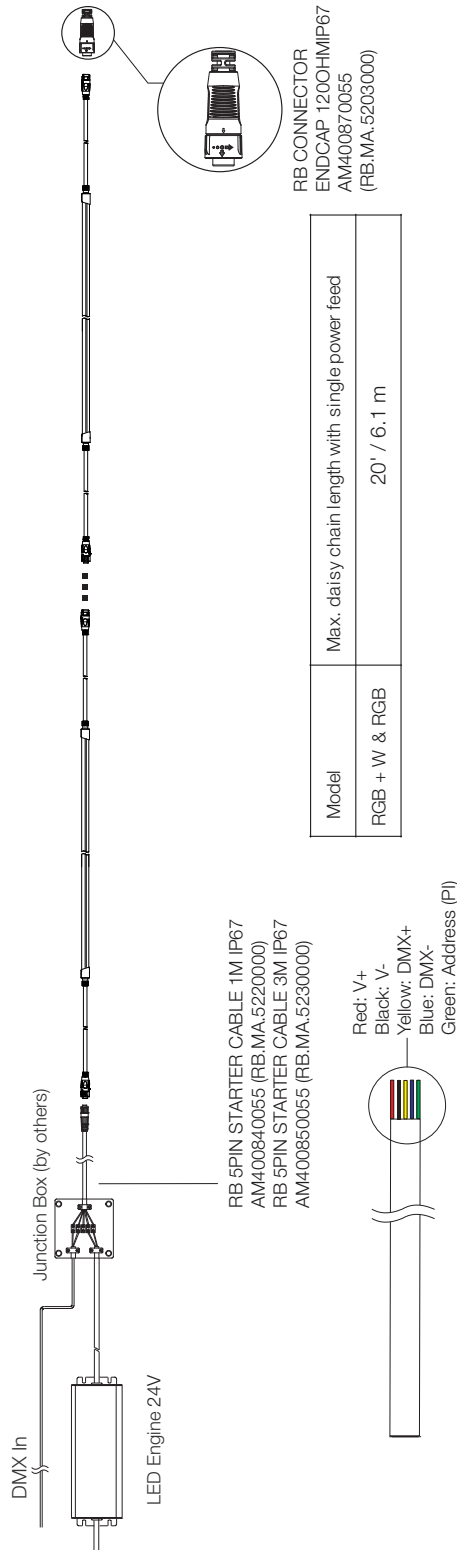

## Typical Power Injection with Wiring Y-Cable

NOTE: Mounting accessories not shown.

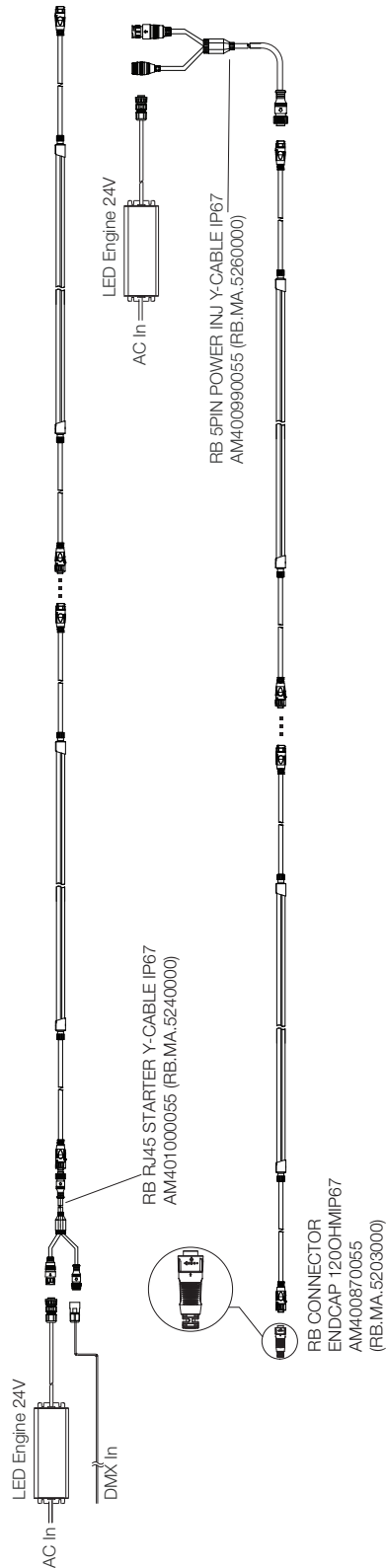

Power injection is required when ribbon connection length reaches the maximum length with single power feed.

## Media Pixel Ribbon RGB VB Outdoor

Ordering

### Fixtures

Model No.	Description	Item Code
RB.UO.6150100	PX RB RGB 61PPR 20FT DX V1 IP67 ETL (END CABLE FEED)	AM433490055
RB.UO.6150120	PX RB RGB 61PPR 20FT DX V2L IP67 ETL (SIDE CABLE FEED LEFT)	AM433560055
RB.UO.6150190	PX RB RGB 61PPR 20FT DX V2R IP67 ETL (SIDE CABLE FEED RIGHT)	AM433630055
RB.UO.6150130	PX RB RGB 61PPR 20FT DX V3 IP67 ETL (BOTTOM CABLE FEED)	AM433700055

### TX Connect

Model No.	Description	Item Code
RB.MA.5220000	RB 5PIN STARTER CABLE 1M IP67	AM400840055
RB.MA.5230000	RB 5PIN STARTER CABLE 3M IP67	AM400850055
RB.MA.5270000	RB 5PIN STARTER CABLE 5M IP67	AM415500055
RB.MA.5260000	RB 5PIN POWER INJ Y-CABLE IP67	AM400990055
RB.MA.5240000	RB RJ45 STARTER Y-CABLE IP67	AM401000055
N/A	RB CONNECTOR ENDCAP IP67	AM400860055
RB.MA.5203000	RB CONNECTOR ENDCAP 120OHM IP67	AM400870055

### TX Cutting tools

Model No.	Description	Item Code
N/A	PX RIBBON CUTTING TOOL	AM412950055
N/A	PX RIBBON SEALING GLUE 100ML	AM412960055
N/A	RX RIBBON VB FIELD CUT ENDCAP 20PC	AM412970055

### TX Mounting

Model No.	Description	Item Code
N/A	FLEXIBLE MOUNT STRIP VB 5M	AM400930055
N/A	SINGLE MOUNT BRACKET VB 20PC	AM400950055
N/A	U-CHANNEL OUTDOOR VB 950	AM400970055

### TX Power Supply

Model No.	Description	Item Code
N/A	LED ENGINE 100W 24V OUTDOOR	AM175860055

### Addressing Device

Please contact your sales representative for details.

Our Brands

traxon e:cue

[www.traxontechnologies.com](http://www.traxontechnologies.com) | [www.osram.us/traxon](http://www.osram.us/traxon)

©2021 TRAXON TECHNOLOGIES - AN OSRAM BUSINESS. ALL RIGHTS RESERVED. TRAXON™, TX CONNECT®, ARE TRADEMARKS OF TRAXON TECHNOLOGIES. U.S. PATENTS, E.U. PATENTS, JAPAN PATENTS, OTHER PATENTS PENDING. SPECIFICATIONS ARE SUBJECT TO CHANGE WITHOUT NOTICE.

OSRAM