

Date: _____ Quantity: _____

Company: _____

Project: _____



ProPoint™ Linear HO Static White + Color

The ProPoint Linear Static White + Color is an AC Line powered luminaire in a slim profile. The ProPoint Linear is available in 8W (SO) or 12W (HO) per foot output, 4 beam options, standard & custom finishes which can meet the needs for most projects. The daisy chain topology is augmented with a separate Data Injector allowing single cable feed combining data and power to fixtures.

Product Specifications

Model	ProPoint Linear HO Static White 1'	ProPoint Linear HO Static White 4'
Light Source	5 LED	20 LED
Color Range	3000K / 4000K Standard 2200K, 2700K, 3500K, 5000K, 6500K, Red, Green, Blue, Amber available ¹	
Beam Angle	15°, 25°, 35°, 50° x 30°, 105° x 105°	
Luminous Flux	970 / 1157 lm @15°	3982 / 4740 lm @15°
Efficacy	76 / 89 lm/W @15°	79 / 96 lm/W @15°
Lumen Maintenance	L ₇₀ @25° 81,000 hours	
Cover Lens	Tempered Glass	
Housing	Die Cast Aluminum	
Adjustment Options	±90°	
Size	300mm x 58mm x 90mm (12" x 2.3" x 3.6")	1200mm x 58mm x 90mm (48" x 2.3" x 3.6")
Weight	1.35 kg (3 lbs.)	3.6 kg (8 lbs.)
Regulatory/Product Certifications	CE, FCC, RoHS, REACH, ASTM B117-16, ANSI 3G, IK08	
Operating Temperature	-30°C to +55°C (-22°F to +131°F)	
Minimum Starting Temperature	-20°C (-4°F)	
Storage Temperature	-40°C to +80°C (-40°F to +176°F)	
Environment	IP66 Outdoor, suitable for coastal environments	
Humidity	85%, non-condensing	

Electrical Specifications

Input Voltage¹	100-277V _{AC} 50/60Hz	
Wattage	12W	48 W
Power Factor	≥0.9	

System Specifications

Power	AC Line
Control	DMX512, RDM Enabled
Power Supply	Integrated

1. No MOQ required. Please consult regional sales office for pricing and lead time.
2. Auto-switching. Single phase (line, neutral and ground).

LED CHARACTERISTICS: Because LEDs are semiconductor devices, their performances are subject to inherent variability commonly found in semiconductor industry. To improve consistency in performance across the same product, LED manufacturers "sort" LEDs into bins according to different preset parameters, such as forward driving voltage, illumination, etc. Whereas binning is a sorting function, it is not a correction process. Inherent variability in the manufacturing process always results in different binning distributions according to different production lots. Traxon uses automatically binned LEDs on its products, thereby minimizing output variations within the model range.

As with all electronic devices, LED output degrades over time – a term called lumen depreciation. This also explains why it is nearly impossible to expect photometric performances of two LED products with different service life spans to be the same. The rate of LED degrade is a complicated function involving many factors, such as operating efficiency, duration of continuous operation and, more significantly, environmental conditions (ambient temperature for example). If allowed, working under optimal operating temperature range and with good ventilation, LED devices enjoy long service lives over conventional light sources. When using/installing LED devices, care should be taken to ensure that the devices will operate within the operating conditions specified in respective product literature.

Lumen measurement complies with LM-79-08 standard.
Lumen maintenance is calculated based on LM-80 compliant measurement.

www.traxontechnologies.com
www.osram.us/traxon

©2019 TRAXON TECHNOLOGIES - AN OSRAM BUSINESS. ALL RIGHTS RESERVED. TRAXON™ AND TX CONNECT® ARE TRADEMARKS OF TRAXON TECHNOLOGIES. U.S. PATENTS, E.U. PATENTS, JAPAN PATENTS, OTHER PATENTS PENDING. SPECIFICATIONS ARE SUBJECT TO CHANGE WITHOUT NOTICE.

Source Specifications

LED Source	5 LED / 20 LED
Beam Angle	15°
Cover Lens	Tempered Glass

Candela Distribution

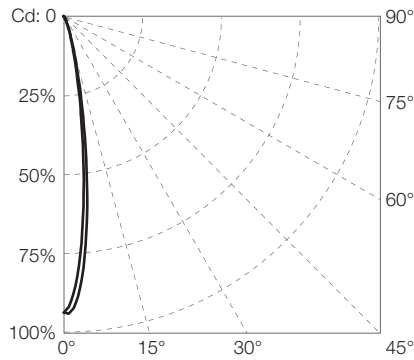

Diagram based on HO 3000K 15°

Light Output

Color Temperature	Luminous Flux (lm)	Candela Distribution @100%	Efficacy (lm/W)
ProPoint Linear HO Static White 15° 1'			
3000K	970.88	7,507.30	76.45
4000K	1,157.8	8,834.26	89.75
ProPoint Linear HO Static White 15° 4'			
3000K	3,982.1	30,119.35	79.17
4000K	4,740.1	34,421.43	96.54

Illuminance at a Distance

ProPoint Linear HO Static White 15° 1'

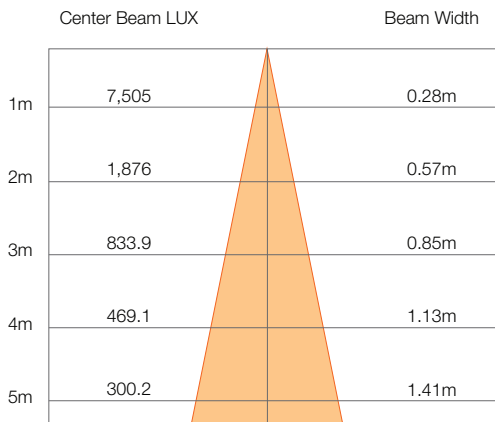

● Vert. Spread: 16.1°
 ● Horiz. Spread: 16.1°

For feet multiply by 3.28

For fc divide by 10.7

ProPoint Linear HO Static White 15° 4'

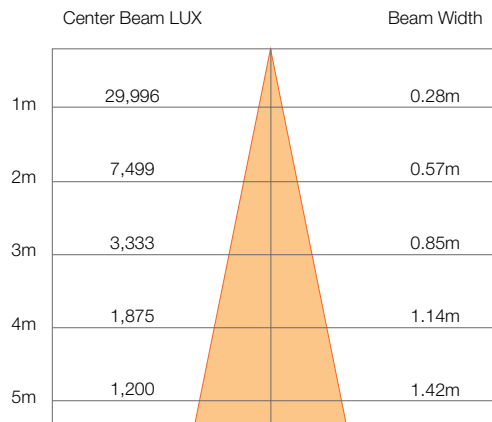

● Vert. Spread: 16.2°
 ● Horiz. Spread: 16.2°

For feet multiply by 3.28

For fc divide by 10.7

Diagrams based on HO 3000K 15° measurements

ProPoint™ Linear HO Static White + Color

Photometrics

Source Specifications

LED Source	5 LED / 20 LED
Beam Angle	25°
Cover Lens	Tempered Glass

Candela Distribution

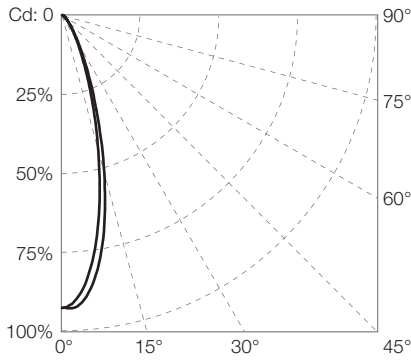

Light Output

Color Temperature	Luminous Flux (lm)	Candela Distribution @100%	Efficacy (lm/W)
ProPoint Linear HO Static White 25° 1'			
3000K	881.79	2,315.07	68.36
4000K	1,047.9	2,769.94	81.23
ProPoint Linear HO Static White 25° 4'			
3000K	3,532.2	9,092.28	69.94
4000K	4,233.2	10,983.19	86.39

Illuminance at a Distance

ProPoint Linear HO Static White 25° 1'

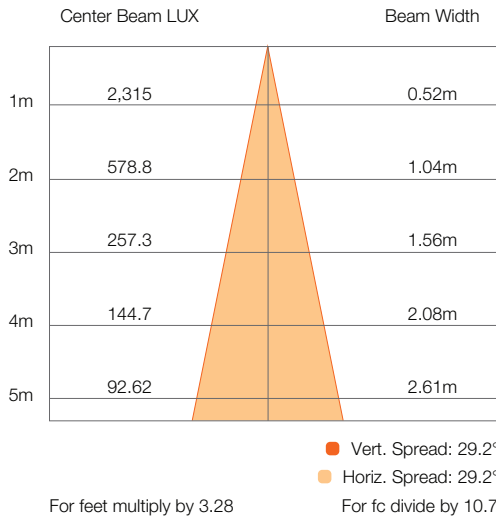

ProPoint Linear HO Static White 25° 4'

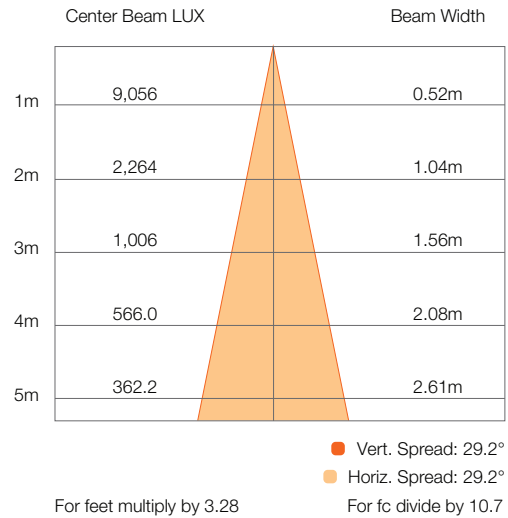

Diagrams based on HO 3000K 25° measurements

Source Specifications

LED Source	5 LED / 20 LED
Beam Angle	35°
Cover Lens	Tempered Glass

Candela Distribution

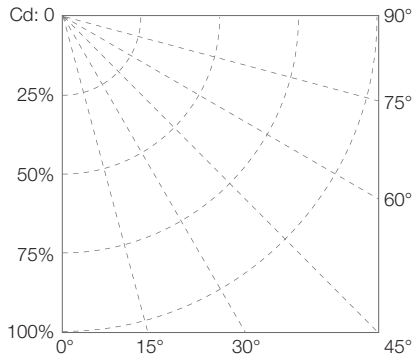

Diagram based on HO 3000K 35°

Light Output

Color Temperature	Luminous Flux (lm)	Candela Distribution @100%	Efficacy (lm/W)
ProPoint Linear HO Static White 35° 1'			
3000K	932.95	1,563.13	72.89
4000K	1,104.5	1,784.93	85.62
ProPoint Linear HO Static White 35° 4'			
3000K	3,749.3	5,936.84	74.39
4000K	4,492.9	7,103.87	91.32

Illuminance at a Distance

ProPoint Linear HO Static White 35° 1'

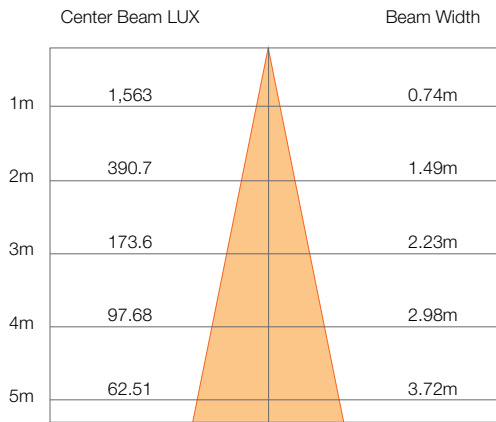

- Vert. Spread: 40.9°
- Horiz. Spread: 40.9°

For feet multiply by 3.28

For fc divide by 10.7

ProPoint Linear HO Static White 35° 4'

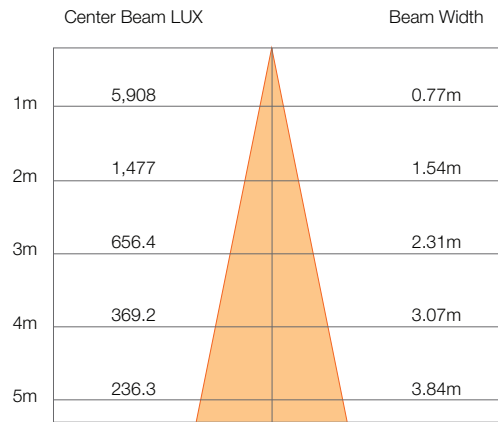

- Vert. Spread: 42.0°
- Horiz. Spread: 42.0°

For feet multiply by 3.28

For fc divide by 10.7

Diagrams based on HO 3000K 35° measurements

Source Specifications

LED Source	5 LED / 20 LED
Beam Angle	50° x 30°
Cover Lens	Tempered Glass

Candela Distribution

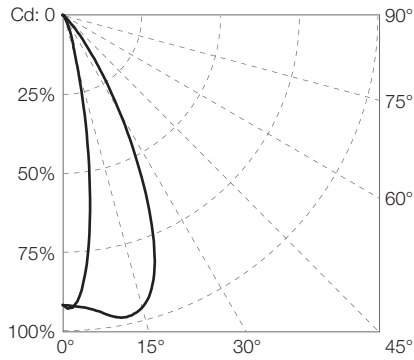

Diagram based on HO 3000K 50x30°

Light Output

Color Temperature	Luminous Flux (lm)	Candela Distribution @100%	Efficacy (lm/W)
ProPoint Linear HO Static White 50° x 30° 1'			
3000K	880.93	2,481.98	68.82
4000K	1,057.2	3,069.84	81.32
ProPoint Linear HO Static White 50° x 30° 4'			
3000K	3,527.7	9,752.05	70.13
4000K	4,243	11,956.99	86.95

Illuminance at a Distance

ProPoint Linear HO Static White 50° x 30° 1'

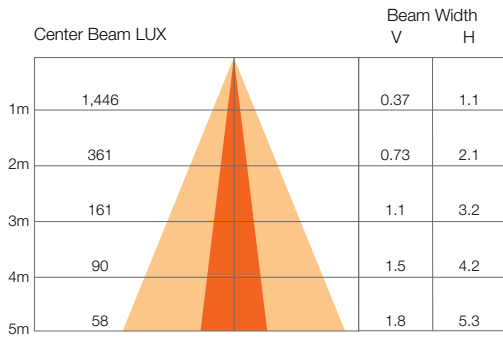

● Vert Spread: 20.8°
 ● Horiz Spread: 55.4°

For feet multiply by 3.28

For fc divide by 10.7

ProPoint Linear HO Static White 50° x 30° 4'

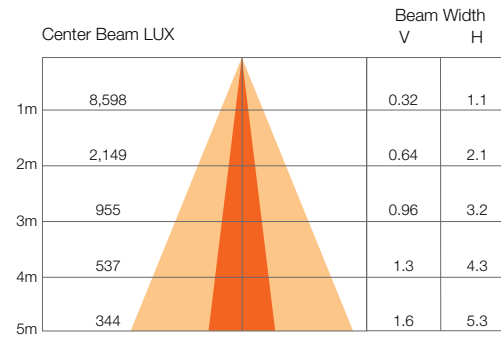

● Vert Spread: 18.2°
 ● Horiz Spread: 56.2°

For feet multiply by 3.28

For fc divide by 10.7

Diagrams based on HO 3000K 50° x 30° measurements

ProPoint™ Linear HO Static White + Color

Dimensions

ProPoint™ Linear 1'

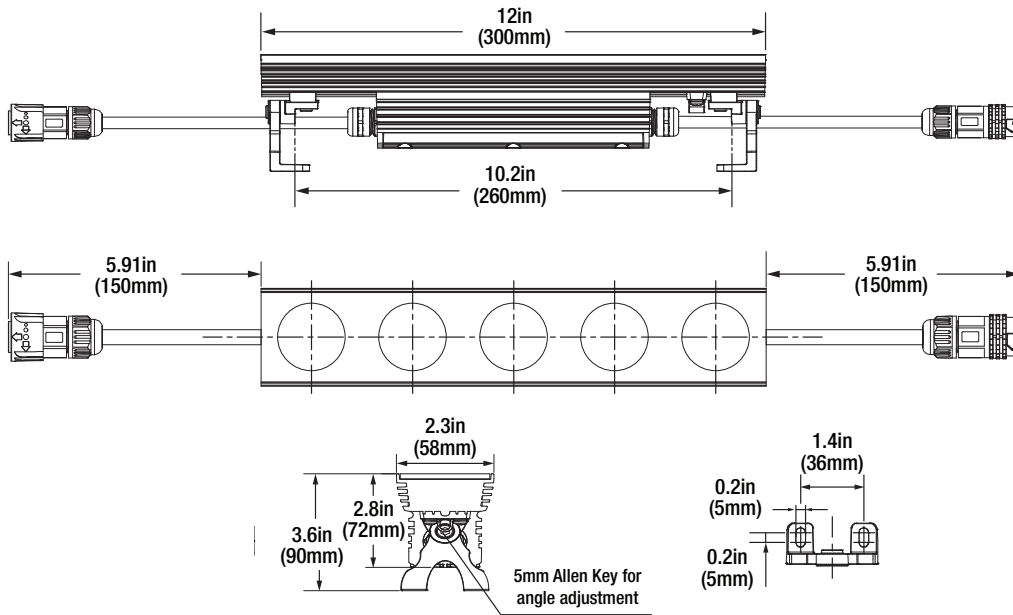

ProPoint Linear 4'

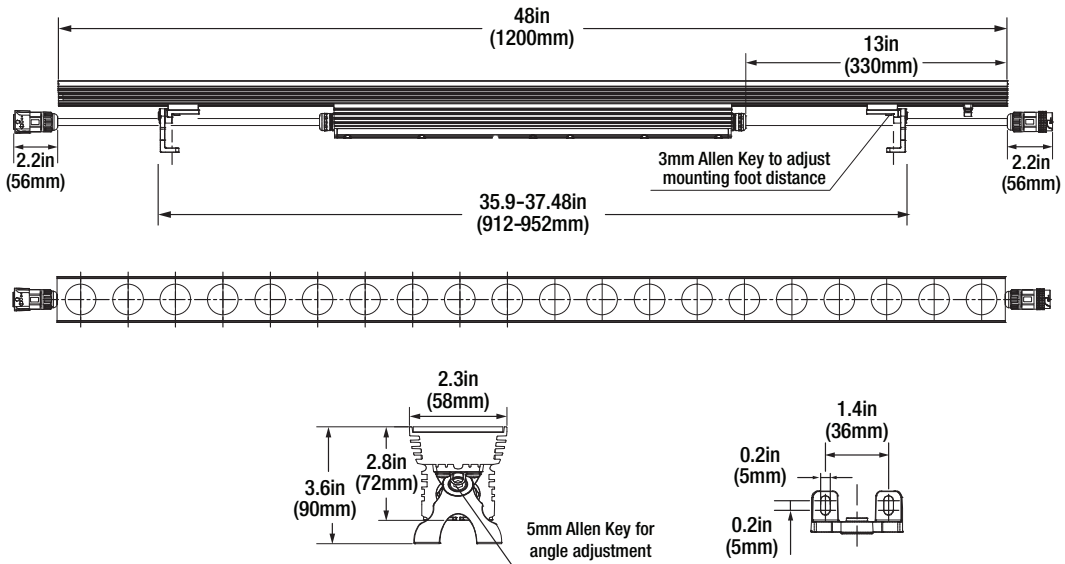

www.traxontechnologies.com
www.osram.us/traxon

©2019 TRAXON TECHNOLOGIES - AN OSRAM BUSINESS. ALL RIGHTS RESERVED. TRAXON™ AND TX CONNECT® ARE TRADEMARKS OF TRAXON TECHNOLOGIES. U.S. PATENTS, E.U. PATENTS, JAPAN PATENTS, OTHER PATENTS PENDING. SPECIFICATIONS ARE SUBJECT TO CHANGE WITHOUT NOTICE.

ProPoint™ Linear HO Static White + Color

System Diagram

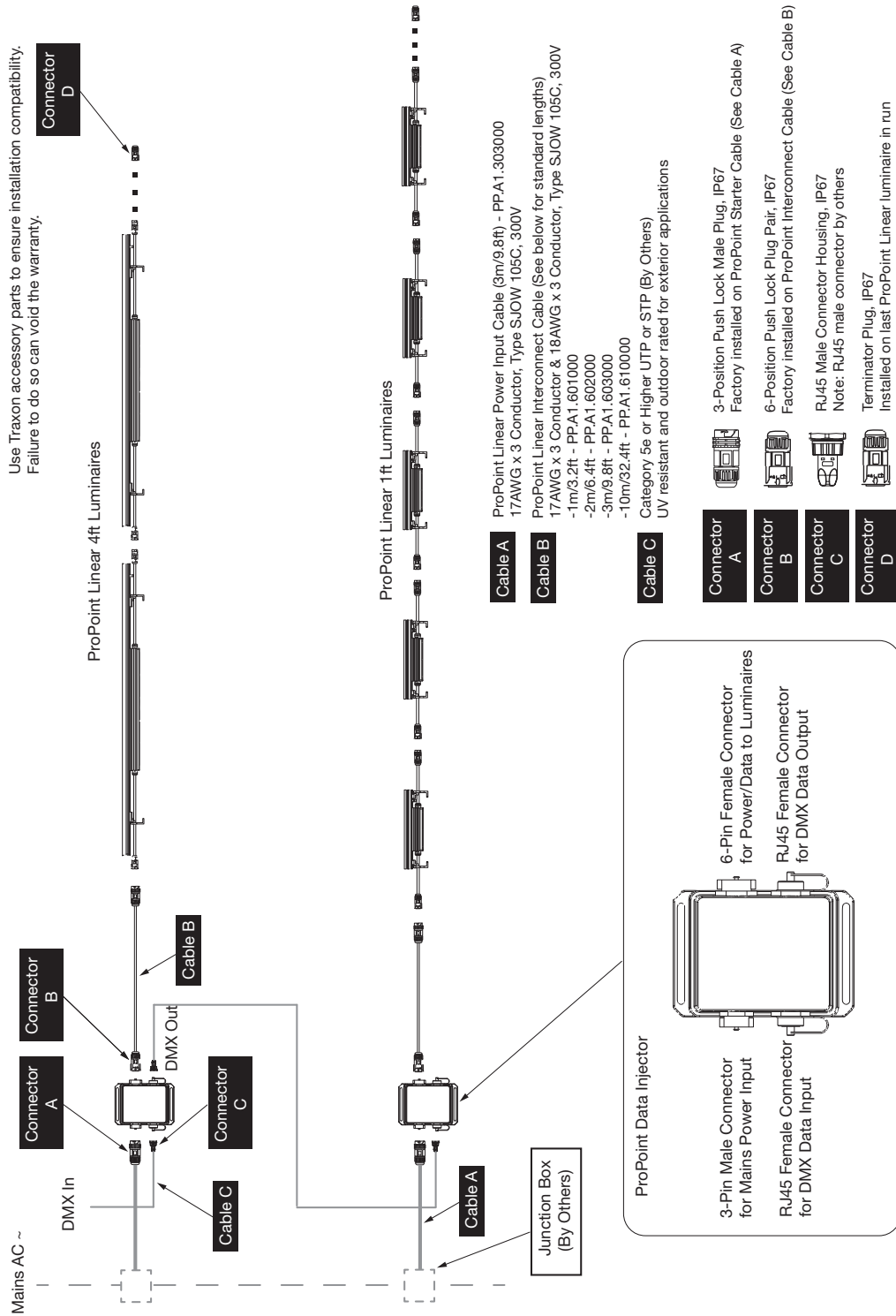

www.traxontechnologies.com
www.osram.us/traxon

©2019 TRAXON TECHNOLOGIES - AN OSRAM BUSINESS. ALL RIGHTS RESERVED. TRAXON™ AND TX CONNECT® ARE TRADEMARKS OF TRAXON TECHNOLOGIES. U.S. PATENTS, E.U. PATENTS, JAPAN PATENTS, OTHER PATENTS PENDING. SPECIFICATIONS ARE SUBJECT TO CHANGE WITHOUT NOTICE.

ProPoint™ Linear HO Static White + Color

Ordering

Model Number

PP	.	XX	.	9	1	X	6	X	X
ProPoint		Linear HO		Control	Color	CCT	Approbation	Optic	Finish
		L1 - 4' 48W		9: DMX	1: Static White	3: 3000K	6: CE	2: 15°	1: Gray
		L4 - 1' 12W				4: 4000K		3: 25°	2: Black
								4: 35°	3: White
								5: 50° x 30°	
								6: 105° x 105°	

Fixtures

Model Number	Description	Item Code
PP.L4.913621	ProPoint Linear HO (12W) 1' 3000K 15° (CE)	
PP.L4.913631	ProPoint Linear HO (12W) 1' 3000K 25° (CE)	
PP.L4.913641	ProPoint Linear HO (12W) 1' 3000K 35° (CE)	
PP.L4.913651	ProPoint Linear HO (12W) 1' 3000K 50°x30° (CE)	
PP.L1.913621	ProPoint Linear HO (48W) 4' 3000K 15° (CE)	
PP.L1.913631	ProPoint Linear HO (48W) 4' 3000K 25° (CE)	
PP.L1.913641	ProPoint Linear HO (48W) 4' 3000K 35° (CE)	
PP.L1.913651	ProPoint Linear HO (48W) 4' 3000K 50°x30° (CE)	
PP.L4.914621	ProPoint Linear HO (12W) 1' 4000K 15° (CE)	
PP.L4.914631	ProPoint Linear HO (12W) 1' 4000K 25° (CE)	
PP.L4.914641	ProPoint Linear HO (12W) 1' 4000K 35° (CE)	
PP.L4.914651	ProPoint Linear HO (12W) 1' 4000K 50°x30° (CE)	
PP.L1.914621	ProPoint Linear HO (48W) 4' 4000K 15° (CE)	
PP.L1.914631	ProPoint Linear HO (48W) 4' 4000K 25° (CE)	
PP.L1.914641	ProPoint Linear HO (48W) 4' 4000K 35° (CE)	
PP.L1.914651	ProPoint Linear HO (48W) 4' 4000K 50°x30° (CE)	
PP.L4.913622	ProPoint Linear HO (12W) 1' 3000K 15° BL (CE)	
PP.L4.913632	ProPoint Linear HO (12W) 1' 3000K 25° BL (CE)	
PP.L4.913642	ProPoint Linear HO (12W) 1' 3000K 35° BL (CE)	
PP.L4.913652	ProPoint Linear HO (12W) 1' 3000K 50°x30° BL (CE)	
PP.L1.913622	ProPoint Linear HO (48W) 4' 3000K 15° BL (CE)	
PP.L1.913632	ProPoint Linear HO (48W) 4' 3000K 25° BL (CE)	
PP.L1.913642	ProPoint Linear HO (48W) 4' 3000K 35° BL (CE)	
PP.L1.913652	ProPoint Linear HO (48W) 4' 3000K 50°x30° BL (CE)	

www.traxontechnologies.com
www.osram.us/traxon

©2019 TRAXON TECHNOLOGIES - AN OSRAM BUSINESS. ALL RIGHTS RESERVED. TRAXON™ AND TX CONNECT® ARE TRADEMARKS OF TRAXON TECHNOLOGIES. U.S. PATENTS, E.U. PATENTS, JAPAN PATENTS, OTHER PATENTS PENDING. SPECIFICATIONS ARE SUBJECT TO CHANGE WITHOUT NOTICE.

Fixtures (continued)

Model Number	Description	Item Code
PPL4.914622	ProPoint Linear HO (12W) 1' 4000K 15° BL (CE)	
PPL4.914632	ProPoint Linear HO (12W) 1' 4000K 25° BL (CE)	
PPL4.914642	ProPoint Linear HO (12W) 1' 4000K 35° BL (CE)	
PPL4.914652	ProPoint Linear HO (12W) 1' 4000K 50°x30° BL (CE)	
PPL1.914622	ProPoint Linear HO (48W) 4' 4000K 15° BL (CE)	
PPL1.914632	ProPoint Linear HO (48W) 4' 4000K 25° BL (CE)	
PPL1.914642	ProPoint Linear HO (48W) 4' 4000K 35° BL (CE)	
PPL1.914652	ProPoint Linear HO (48W) 4' 4000K 50°x30° BL (CE)	
PPL4.913623	ProPoint Linear HO (12W) 1' 3000K 15° WT (CE)	
PPL4.913633	ProPoint Linear HO (12W) 1' 3000K 25° WT (CE)	
PPL4.913643	ProPoint Linear HO (12W) 1' 3000K 35° WT (CE)	
PPL4.913653	ProPoint Linear HO (12W) 1' 3000K 50°x30° WT (CE)	
PPL1.913623	ProPoint Linear HO (48W) 4' 3000K 15° WT (CE)	
PPL1.913633	ProPoint Linear HO (48W) 4' 3000K 25° WT (CE)	
PPL1.913643	ProPoint Linear HO (48W) 4' 3000K 35° WT (CE)	
PPL1.913653	ProPoint Linear HO (48W) 4' 3000K 50°x30° WT (CE)	
PPL4.914623	ProPoint Linear HO (12W) 1' 4000K 15° WT (CE)	
PPL4.914633	ProPoint Linear HO (12W) 1' 4000K 25° WT (CE)	
PPL4.914643	ProPoint Linear HO (12W) 1' 4000K 35° WT (CE)	
PPL4.914653	ProPoint Linear HO (12W) 1' 4000K 50°x30° WT (CE)	
PPL1.914623	ProPoint Linear HO (48W) 4' 4000K 15° WT (CE)	
PPL1.914633	ProPoint Linear HO (48W) 4' 4000K 25° WT (CE)	
PPL1.914643	ProPoint Linear HO (48W) 4' 4000K 35° WT (CE)	
PPL1.914653	ProPoint Linear HO (48W) 4' 4000K 50°x30° WT (CE)	

ProPoint™ Linear HO Static White + Color

Ordering

Accessories

Model Number	Description	Item Code
PP.AC.100001	ProPoint Data Injector Box (cETLus/CE)	AM280370055
PP.AC.100002	ProPoint Data Injector Box (cETLus/CE) BL	
PP.AC.100003	ProPoint Data Injector Box (cETLus/CE) WT	
PP.AC.600000	ProPoint Linear End Cap w/ Termination Resistor	AM280380055
PP.AC.400000	ProPoint RJ45 Field Install Connectors (pair)	AM280400055
PP.A2.303000	3m Power Input Cable (CE)	
PP.A2.601000	1m ProPoint Linear Power/Data Int Cable (CE)	
PP.A2.602000	2m ProPoint Linear Power/Data Int Cable (CE)	
PP.A2.603000	3m ProPoint Linear Power/Data Int Cable (CE)	
PP.A2.610000	10m ProPoint Linear Power/Data Int Cable (CE)	
PP.LA.200011	Asymmetric Louver 1'	
PP.LA.200012	Asymmetric Louver 1' BL	
PP.LA.200013	Asymmetric Louver 1' WT	
PP.LA.200041	Asymmetric Louver 4'	
PP.LA.200042	Asymmetric Louver 4' BL	
PP.LA.200043	Asymmetric Louver 4' WT	
PP.LA.100001	Wall Mount Arm	
PP.LA.100002	Wall Mount Arm BL	
PP.LA.100003	Wall Mount Arm WT	
PP.AK.000003	ProPoint 3mm Allen Key	
PP.AK.000005	ProPoint 5mm Allen Key	

Our Brands

traxon **ecue**

www.traxontechnologies.com
www.osram.us/traxon

OSRAM

©2019 TRAXON TECHNOLOGIES - AN OSRAM BUSINESS. ALL RIGHTS RESERVED. TRAXON™ AND TX CONNECT® ARE TRADEMARKS OF TRAXON TECHNOLOGIES. U.S. PATENTS, E.U. PATENTS, JAPAN PATENTS, OTHER PATENTS PENDING. SPECIFICATIONS ARE SUBJECT TO CHANGE WITHOUT NOTICE.